



Compact enclosure RSA IP 66

RSA – is a small wall-mounted enclosure, universal in terms of configuration and use. The standard offer includes 63 dimensions. Tables with catalogue numbers are available on the following pages of the catalogue.



Download product data sheet!

Type	Corrosivity category	Material / additional description	Coating
RSA	C2	steel sheet	RAL7035
RSA-P	C2	steel sheet / transparent door	RAL7035
RSA-ZN	C3	steel sheet + epoxy primer	RAL7035
RSA-AL	C3*	aluminum sheet	RAL7035
RSA-OH	C4**	stainless steel 1.4301 (AISI 304)	BRUSHED
RSA-KO	CX**	acid-proof steel 1.4404 (AISI 316L)	BRUSHED

General information:

- Ingress protection according to IP code: 66
- Impact resistance according to IK code: 10
- Operating temperature range: -30 – +80°C

Basic data:

- Body: monobloc type, welded
- Closure: hinged door with 105° opening angle; the possibility of independent change of the door opening direction; enclosures up to 500 mm height have one D5 type lock whereas higher enclosures have two locks of the same type
- Mounting plate: in each version is made of 2 mm thick galvanized steel sheet
- Cable entry: there is a gland plate in the bottom, its dimensions depend on the width of the enclosure
- Grounding: threaded grounding studs in the door and enclosure body
- Other information: The door has an internal stiffening made of perforated z-bars to facilitate mounting of additional elements.

Description	Page
Locks	90
Mounting plates	95
Vertical beams	100-101
Modular constructions	102-103
Internal doors	106-107
Plinths	115
Cable entry	119-121
Wall brackets	130
Ventilation	81
Heaters	82-83
Air conditioners	85-89

Additional options:

- Increase of the operating temperature range from -50 to +120°C
- Unusual dimensions
- Punching in the door, body or mounting plate
- Painting to any color according to the RAL palette

The technical documentation is available on pages 142-143

The following table presents enclosures equipped with a mounting plate.

No.	Dimensions (W × H × D mm)	Catalogue No. RSA	Catalogue No. RSA-P	Catalogue No. RSA-ZN	Catalogue No. RSA-AL	Catalogue No. RSA-OH	Catalogue No. RSA-KO
1	200 × 300 × 150	100-001	102-001	100-101	100-201	104-001	104-101
2	300 × 200 × 150	100-002	102-002	100-102	100-202	104-002	104-102
3	300 × 300 × 150	100-003	102-003	100-103	100-203	104-003	104-103
4	300 × 300 × 210	100-004	102-004	100-104	100-204	104-004	104-104
5	300 × 300 × 250	100-005	102-005	100-105	100-205	104-005	104-105
6	300 × 400 × 150	100-006	102-006	100-106	100-206	104-006	104-106
7	300 × 400 × 210	100-007	102-007	100-107	100-207	104-007	104-107
8	300 × 400 × 250	100-008	102-008	100-108	100-208	104-008	104-108
9	300 × 500 × 210	100-009	102-009	100-109	100-209	104-009	104-109
10	400 × 300 × 150	100-010	102-010	100-110	100-210	104-010	104-110
11	400 × 300 × 210	100-011	102-011	100-111	100-211	104-011	104-111
12	400 × 300 × 250	100-012	102-012	100-112	100-212	104-012	104-112
13	400 × 400 × 150	100-013	102-013	100-113	100-213	104-013	104-113
14	400 × 400 × 210	100-014	102-014	100-114	100-214	104-014	104-114
15	400 × 400 × 250	100-015	102-015	100-115	100-215	104-015	104-115
16	400 × 400 × 300	100-016	102-016	100-116	100-216	104-016	104-116
17	400 × 500 × 210	100-017	102-017	100-117	100-217	104-017	104-117
18	400 × 500 × 250	100-018	102-018	100-118	100-218	104-018	104-118
19	400 × 500 × 300	100-019	102-019	100-119	100-219	104-019	104-119
20	400 × 600 × 210	100-020	102-020	100-120	100-220	104-020	104-120
21	400 × 600 × 250	100-021	102-021	100-121	100-221	104-021	104-121
22	400 × 600 × 300	100-022	102-022	100-122	100-222	104-022	104-122
23	400 × 800 × 210	100-023	102-023	100-123	100-223	104-023	104-123
24	400 × 800 × 250	100-024	102-024	100-124	100-224	104-024	104-124
25	400 × 800 × 300	100-025	102-025	100-125	100-225	104-025	104-125
26	400 × 1000 × 250	100-026	102-026	100-126	100-226	104-026	104-126
27	400 × 1000 × 300	100-027	102-027	100-127	100-227	104-027	104-127
28	500 × 500 × 210	100-028	102-028	100-128	100-228	104-028	104-128
29	500 × 500 × 300	100-029	102-029	100-129	100-229	104-029	104-129
30	500 × 600 × 210	100-030	102-030	100-130	100-230	104-030	104-130
31	500 × 600 × 250	100-031	102-031	100-131	100-231	104-031	104-131
32	500 × 600 × 300	100-032	102-032	100-132	100-232	104-032	104-132
33	500 × 700 × 250	100-033	102-033	100-133	100-233	104-033	104-133
34	600 × 400 × 210	100-034	102-034	100-134	100-234	104-034	104-134
35	600 × 400 × 250	100-035	102-035	100-135	100-235	104-035	104-135
36	600 × 400 × 300	100-036	102-036	100-136	100-236	104-036	104-136
37	600 × 500 × 300	100-037	102-037	100-137	100-237	104-037	104-137
38	600 × 600 × 210	100-038	102-038	100-138	100-238	104-038	104-138
39	600 × 600 × 250	100-039	102-039	100-139	100-239	104-039	104-139
40	600 × 600 × 300	100-040	102-040	100-140	100-240	104-040	104-140
41	600 × 600 × 400	100-041	102-041	100-141	100-241	104-041	104-141
42	600 × 800 × 210	100-042	102-042	100-142	100-242	104-042	104-142
43	600 × 800 × 250	100-043	102-043	100-143	100-243	104-043	104-143
44	600 × 800 × 300	100-044	102-044	100-144	100-244	104-044	104-144
45	600 × 800 × 400	100-045	102-045	100-145	100-245	104-045	104-145
46	600 × 1000 × 250	100-046	102-046	100-146	100-246	104-046	104-146
47	600 × 1000 × 300	100-047	102-047	100-147	100-247	104-047	104-147
48	600 × 1000 × 400	100-048	102-048	100-148	100-248	104-048	104-148
49	600 × 1200 × 250	100-049	102-049	100-149	100-249	104-049	104-149
50	600 × 1200 × 300	100-050	102-050	100-150	100-250	104-050	104-150
51	600 × 1200 × 400	100-051	102-051	100-151	100-251	104-051	104-151
52	800 × 600 × 250	100-052	102-052	100-152	100-252	104-052	104-152
53	800 × 600 × 300	100-053	102-053	100-153	100-253	104-053	104-153
54	800 × 800 × 210	100-054	102-054	100-154	100-254	104-054	104-154
55	800 × 800 × 250	100-055	102-055	100-155	100-255	104-055	104-155
56	800 × 800 × 300	100-056	102-056	100-156	100-256	104-056	104-156
57	800 × 800 × 400	100-057	102-057	100-157	100-257	104-057	104-157
58	800 × 1000 × 250	100-058	102-058	100-158	100-258	104-058	104-158
59	800 × 1000 × 300	100-059	102-059	100-159	100-259	104-059	104-159
60	800 × 1000 × 400	100-060	102-060	100-160	100-260	104-060	104-160
61	800 × 1200 × 250	100-061	102-061	100-161	100-261	104-061	104-161
62	800 × 1200 × 300	100-062	102-062	100-162	100-262	104-062	104-162
63	800 × 1200 × 400	100-063	102-063	100-163	100-263	104-063	104-163



RSA
IP 66

Scope of delivery:
Assembled enclosure with a key.

The following table presents empty enclosures.

No.	Dimensions (W × H × D mm)	Catalogue No. RSA-N	Catalogue No. RSA-P-N	Catalogue No. RSA-ZN-N	Catalogue No. RSA-AL-N	Catalogue No. RSA-OH-N	Catalogue No. RSA-KO-N
1	200 × 300 × 150	101-001	103-001	101-101	101-201	105-001	105-101
2	300 × 200 × 150	101-002	103-002	101-102	101-202	105-002	105-102
3	300 × 300 × 150	101-003	103-003	101-103	101-203	105-003	105-103
4	300 × 300 × 210	101-004	103-004	101-104	101-204	105-004	105-104
5	300 × 300 × 250	101-005	103-005	101-105	101-205	105-005	105-105
6	300 × 400 × 150	101-006	103-006	101-106	101-206	105-006	105-106
7	300 × 400 × 210	101-007	103-007	101-107	101-207	105-007	105-107
8	300 × 400 × 250	101-008	103-008	101-108	101-208	105-008	105-108
9	300 × 500 × 210	101-009	103-009	101-109	101-209	105-009	105-109
10	400 × 300 × 150	101-010	103-010	101-110	101-210	105-010	105-110
11	400 × 300 × 210	101-011	103-011	101-111	101-211	105-011	105-111
12	400 × 300 × 250	101-012	103-012	101-112	101-212	105-012	105-112
13	400 × 400 × 150	101-013	103-013	101-113	101-213	105-013	105-113
14	400 × 400 × 210	101-014	103-014	101-114	101-214	105-014	105-114
15	400 × 400 × 250	101-015	103-015	101-115	101-215	105-015	105-115
16	400 × 400 × 300	101-016	103-016	101-116	101-216	105-016	105-116
17	400 × 500 × 210	101-017	103-017	101-117	101-217	105-017	105-117
18	400 × 500 × 250	101-018	103-018	101-118	101-218	105-018	105-118
19	400 × 500 × 300	101-019	103-019	101-119	101-219	105-019	105-119
20	400 × 600 × 210	101-020	103-020	101-120	101-220	105-020	105-120
21	400 × 600 × 250	101-021	103-021	101-121	101-221	105-021	105-121
22	400 × 600 × 300	101-022	103-022	101-122	101-222	105-022	105-122
23	400 × 800 × 210	101-023	103-023	101-123	101-223	105-023	105-123
24	400 × 800 × 250	101-024	103-024	101-124	101-224	105-024	105-124
25	400 × 800 × 300	101-025	103-025	101-125	101-225	105-025	105-125
26	400 × 1000 × 250	101-026	103-026	101-126	101-226	105-026	105-126
27	400 × 1000 × 300	101-027	103-027	101-127	101-227	105-027	105-127
28	500 × 500 × 210	101-028	103-028	101-128	101-228	105-028	105-128
29	500 × 500 × 300	101-029	103-029	101-129	101-229	105-029	105-129
30	500 × 600 × 210	101-030	103-030	101-130	101-230	105-030	105-130
31	500 × 600 × 250	101-031	103-031	101-131	101-231	105-031	105-131
32	500 × 600 × 300	101-032	103-032	101-132	101-232	105-032	105-132
33	500 × 700 × 250	101-033	103-033	101-133	101-233	105-033	105-133
34	600 × 400 × 210	101-034	103-034	101-134	101-234	105-034	105-134
35	600 × 400 × 250	101-035	103-035	101-135	101-235	105-035	105-135
36	600 × 400 × 300	101-036	103-036	101-136	101-236	105-036	105-136
37	600 × 500 × 300	101-037	103-037	101-137	101-237	105-037	105-137
38	600 × 600 × 210	101-038	103-038	101-138	101-238	105-038	105-138
39	600 × 600 × 250	101-039	103-039	101-139	101-239	105-039	105-139
40	600 × 600 × 300	101-040	103-040	101-140	101-240	105-040	105-140
41	600 × 600 × 400	101-041	103-041	101-141	101-241	105-041	105-141
42	600 × 800 × 210	101-042	103-042	101-142	101-242	105-042	105-142
43	600 × 800 × 250	101-043	103-043	101-143	101-243	105-043	105-143
44	600 × 800 × 300	101-044	103-044	101-144	101-244	105-044	105-144
45	600 × 800 × 400	101-045	103-045	101-145	101-245	105-045	105-145
46	600 × 1000 × 250	101-046	103-046	101-146	101-246	105-046	105-146
47	600 × 1000 × 300	101-047	103-047	101-147	101-247	105-047	105-147
48	600 × 1000 × 400	101-048	103-048	101-148	101-248	105-048	105-148
49	600 × 1200 × 250	101-049	103-049	101-149	101-249	105-049	105-149
50	600 × 1200 × 300	101-050	103-050	101-150	101-250	105-050	105-150
51	600 × 1200 × 400	101-051	103-051	101-151	101-251	105-051	105-151
52	800 × 600 × 250	101-052	103-052	101-152	101-252	105-052	105-152
53	800 × 600 × 300	101-053	103-053	101-153	101-253	105-053	105-153
54	800 × 800 × 210	101-054	103-054	101-154	101-254	105-054	105-154
55	800 × 800 × 250	101-055	103-055	101-155	101-255	105-055	105-155
56	800 × 800 × 300	101-056	103-056	101-156	101-256	105-056	105-156
57	800 × 800 × 400	101-057	103-057	101-157	101-257	105-057	105-157
58	800 × 1000 × 250	101-058	103-058	101-158	101-258	105-058	105-158
59	800 × 1000 × 300	101-059	103-059	101-159	101-259	105-059	105-159
60	800 × 1000 × 400	101-060	103-060	101-160	101-260	105-060	105-160
61	800 × 1200 × 250	101-061	103-061	101-161	101-261	105-061	105-161
62	800 × 1200 × 300	101-062	103-062	101-162	101-262	105-062	105-162
63	800 × 1200 × 400	101-063	103-063	101-163	101-263	105-063	105-163

Scope of delivery:
Assembled enclosure with a key.

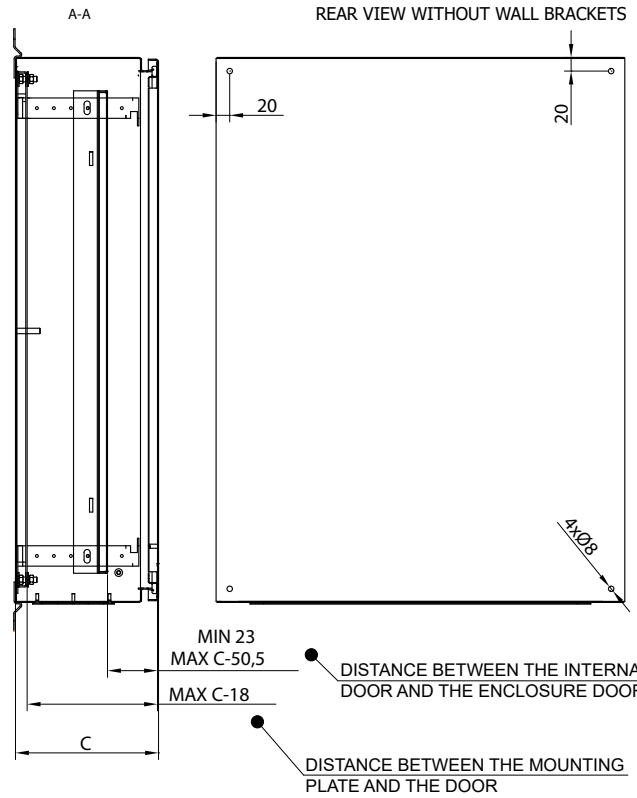
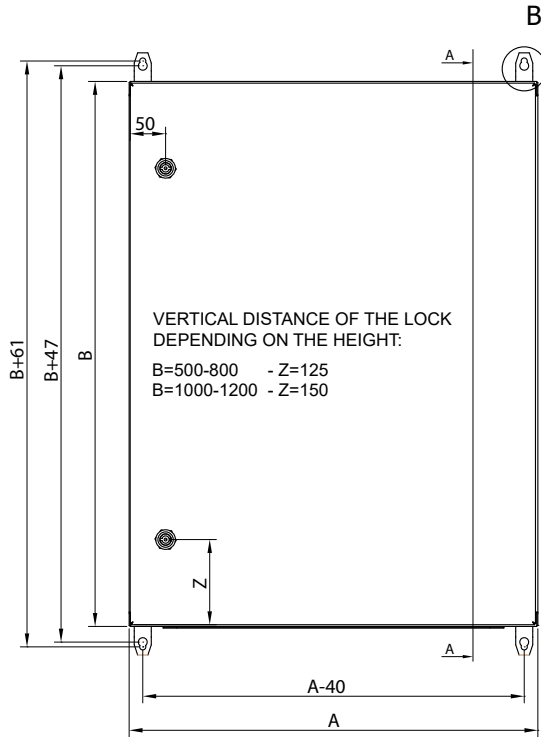
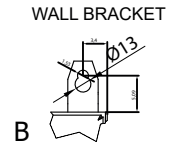
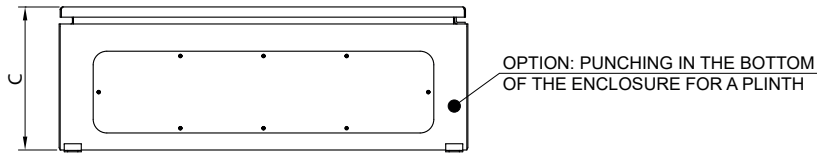

TRANSPARENT DOOR WITH PERFORATED Z-BARS

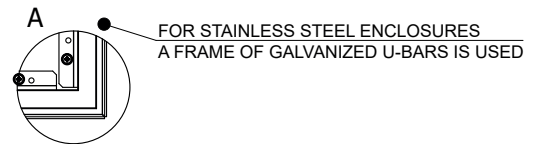
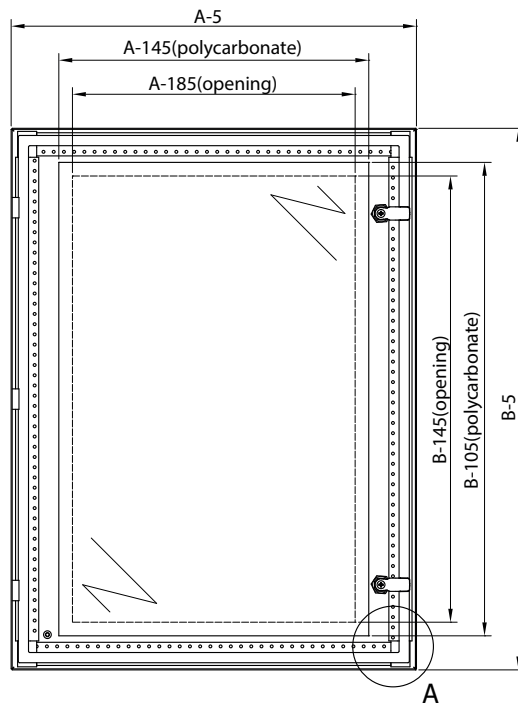

BOTTOM - PUNCHING

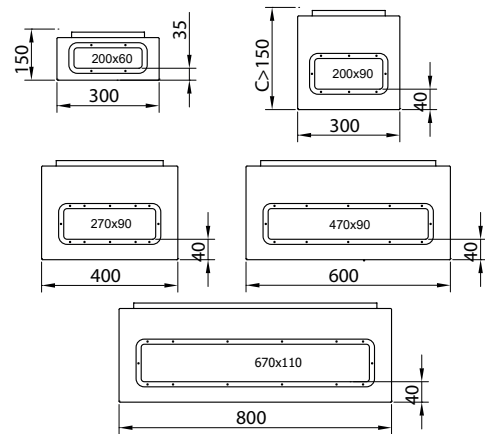

BENDING PROFILE

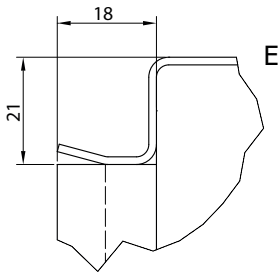

MOUNTING PLATE

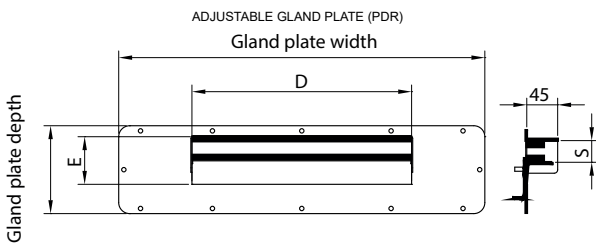
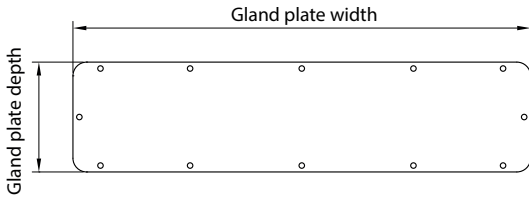
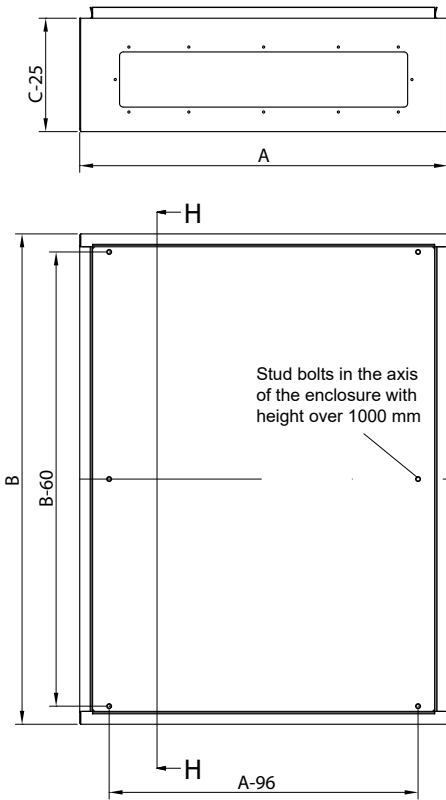
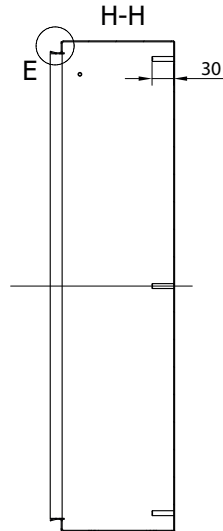
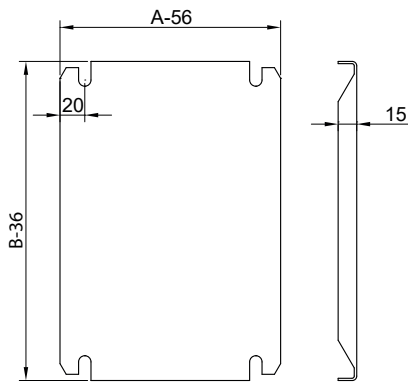

BOTTOM VIEW OF THE PLINTH

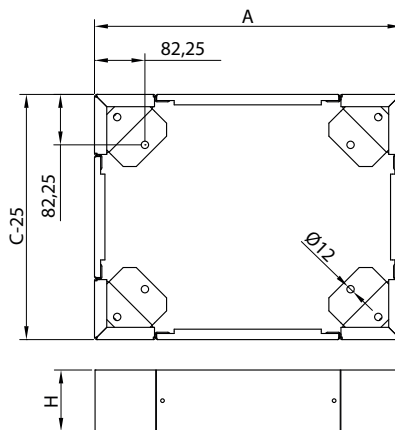

TABLE FOR THE SELECTION OF PDR GLAND PLATES

Enclosure		Gland plate		S		D	E	Gland plate type
Width	Depth	Width	Depth	Min	Max			
300	150	-	-	-	-	-	-	-
	210	-	-	-	-	-	-	-
	250	230	120	18	55	150	65	PDR-3
	300	-	-	-	-	-	-	-
400	150	-	-	-	-	-	-	-
	210	-	-	-	-	-	-	-
	250	300	120	18	55	200	65	PDR-4
	300	-	-	-	-	-	-	-
600	150	-	-	-	-	-	-	-
	210	-	-	-	-	-	-	-
	250	500	120	18	55	300	65	PDR-6
	300	-	-	-	-	-	-	-
800	150	-	-	-	-	-	-	-
	210	-	-	-	-	-	-	-
	250	700	140	18	55	400	65	PDR-8
	300	-	-	-	-	-	-	-

**WALL BRACKET UN-1
4 PCS FOR 1 ENCLOSURE**

